

BLOCK DIAGRAM FOR DILATRONIC III Quench Dilatometer

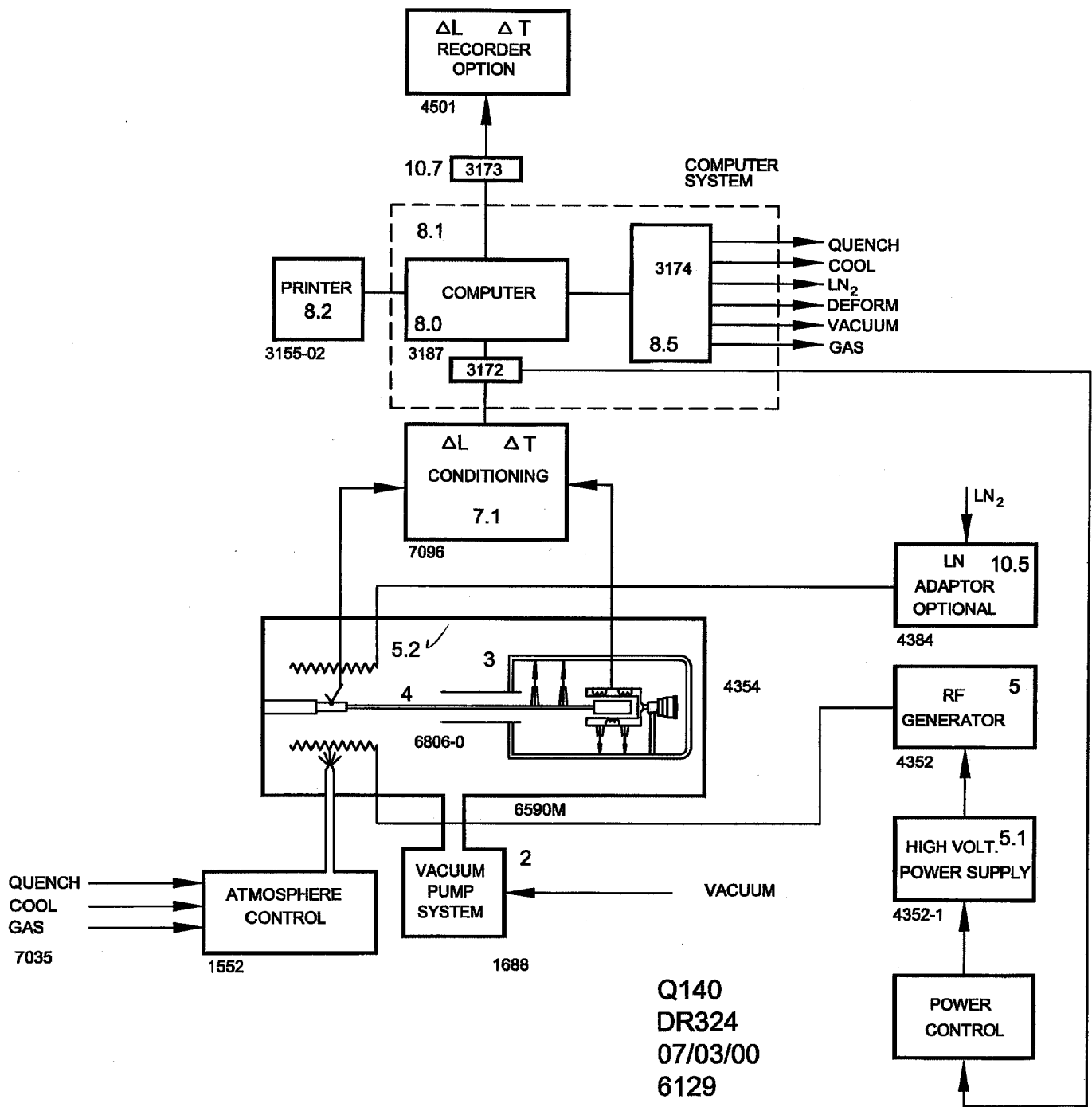

DILATRONIC III



8.3

9



3172

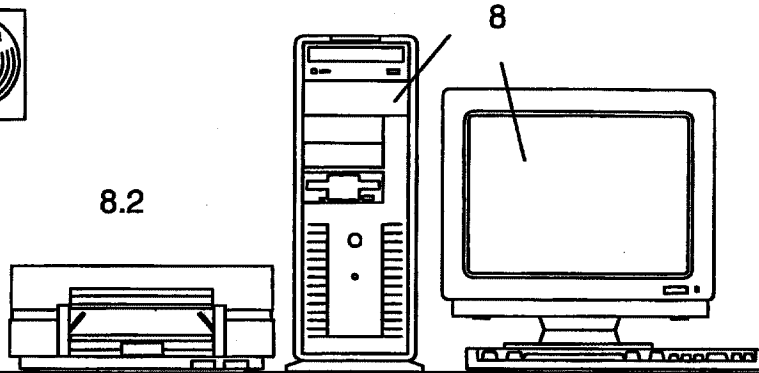

8.2

8

Desk to the right of instrument



5

4354

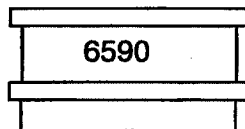

6590



10

1510

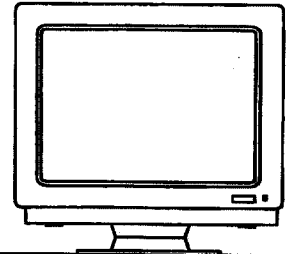

2.0

DR322
07/03/00
Dilatronic III
6129

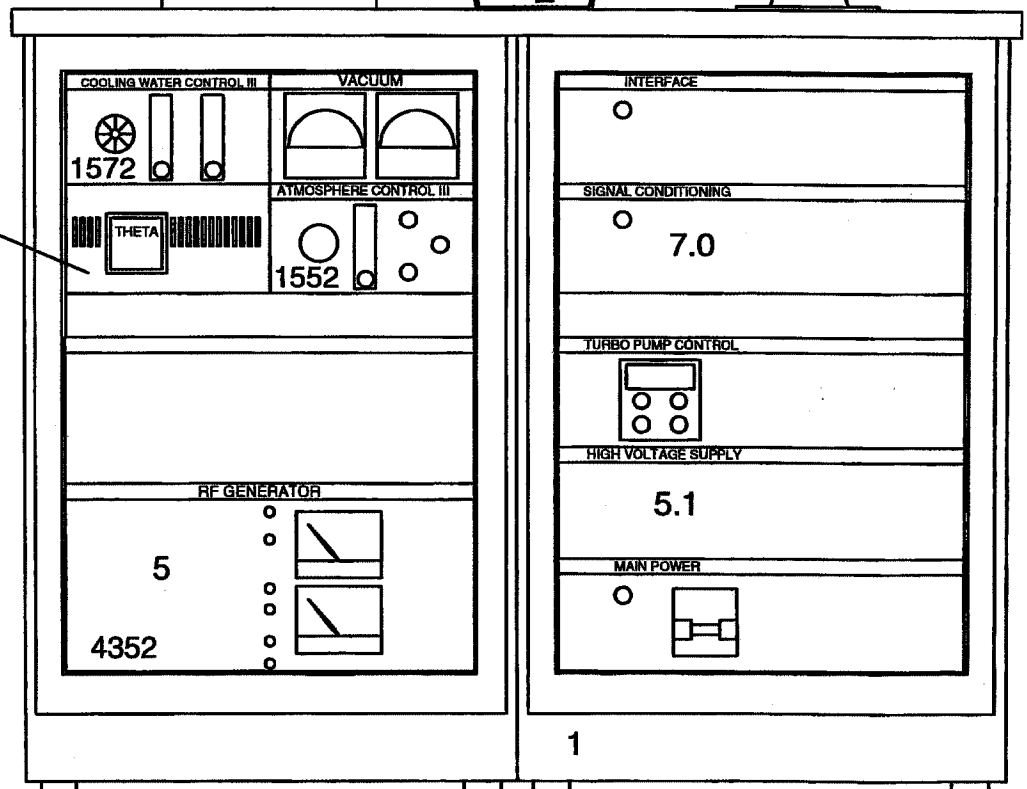

2

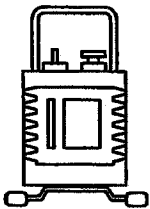

1612

BLOCK DIAGRAM FOR DILATRONIC III Quench / Deformation Dilatometer

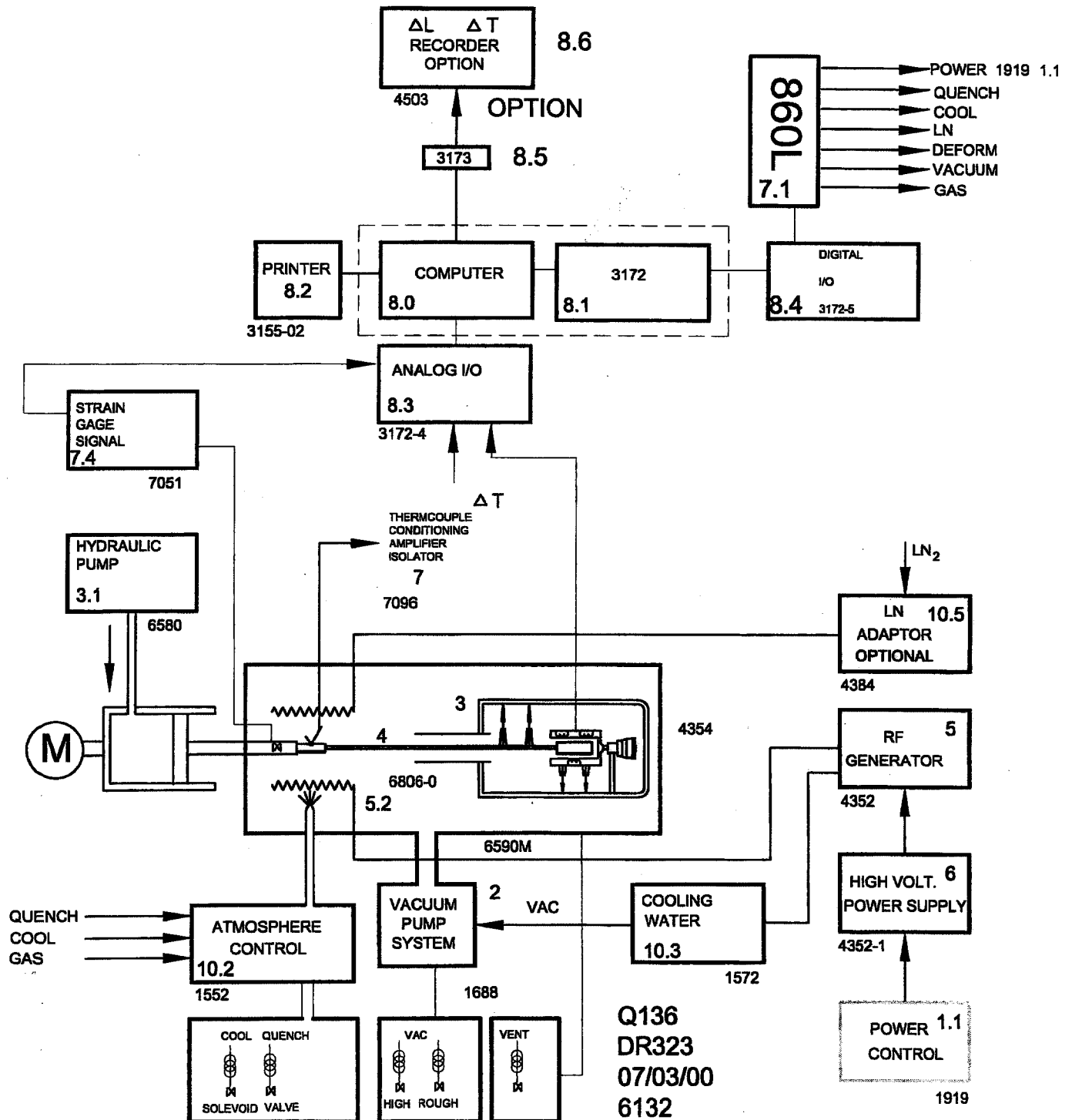

DILATRONIC III



8.3



3172

9

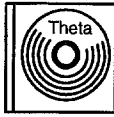

8.2

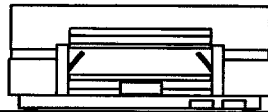

8

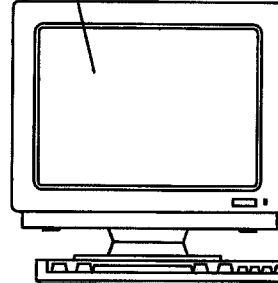
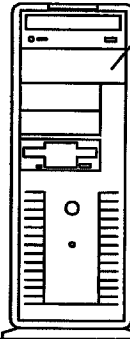

Desk to the right of instrument



4354

5



4356

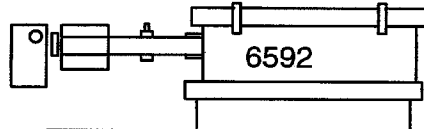

6592

10

1510

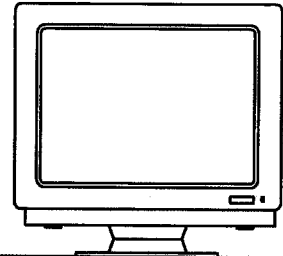

2.0

DR321
07/03/00
Dilatronic III
6132

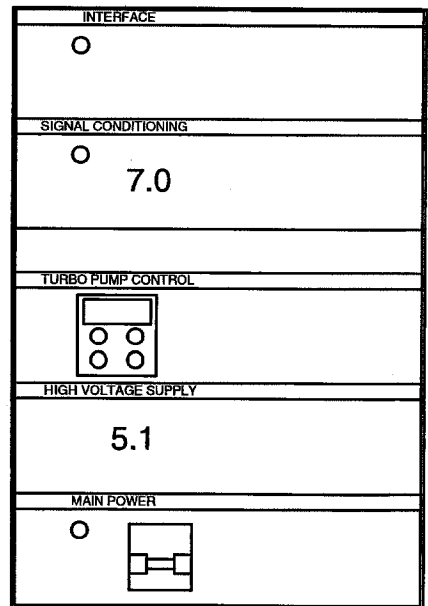
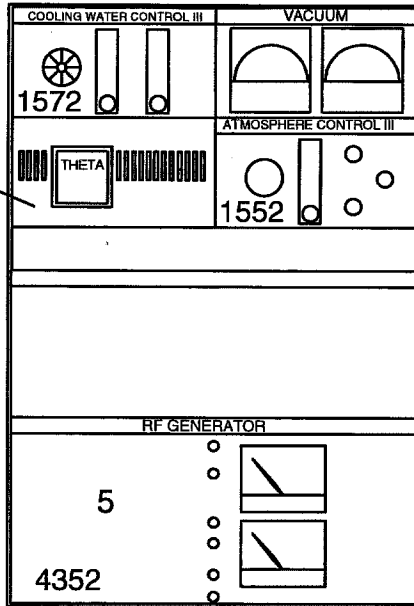

3.1

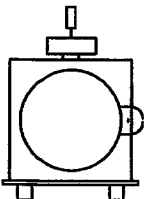

6580

2

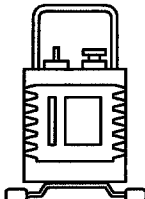

1612

1