

# BLOCK DIAGRAM FOR DILATRONIC III Quench Dilatometer

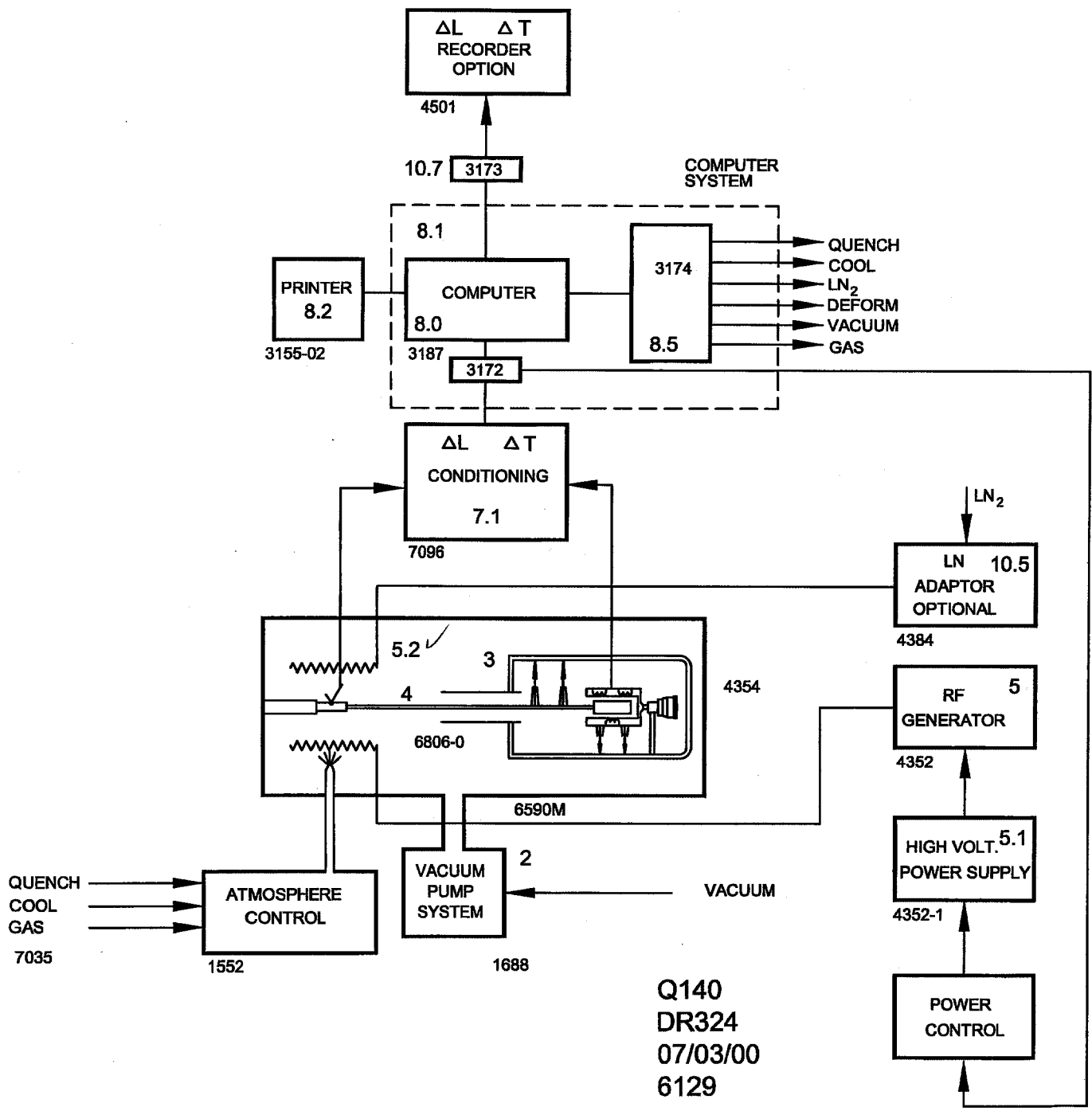

# DILATRONIC III



8.3

9



3172



8.2

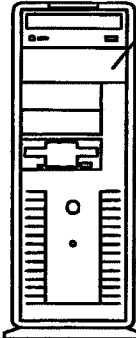
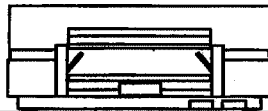

8

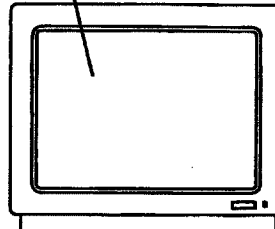

Desk to the right of instrument



5

4354

6590

10

1510

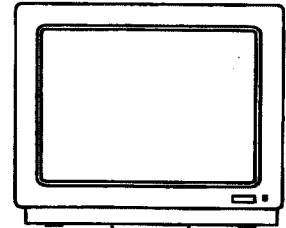

2.0

DR322  
07/03/00  
Dilatronic III  
6129

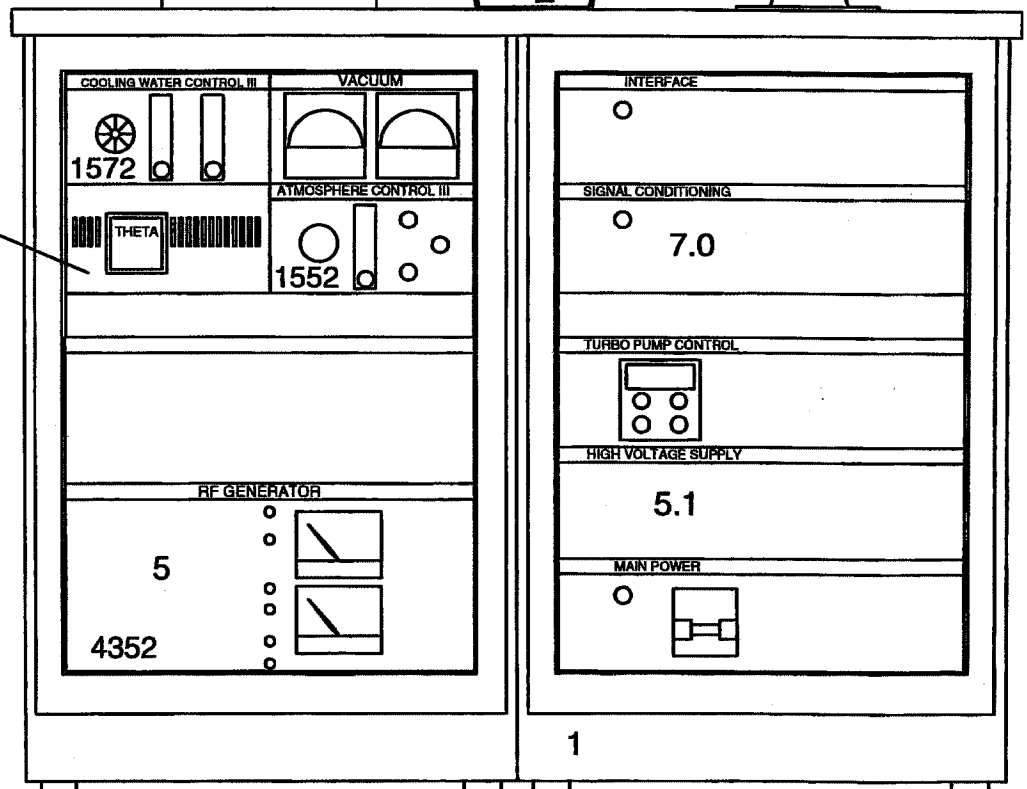

2

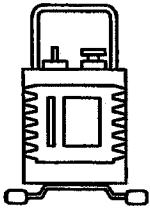

1612

# BLOCK DIAGRAM FOR DILATRONIC III Quench / Deformation Dilatometer

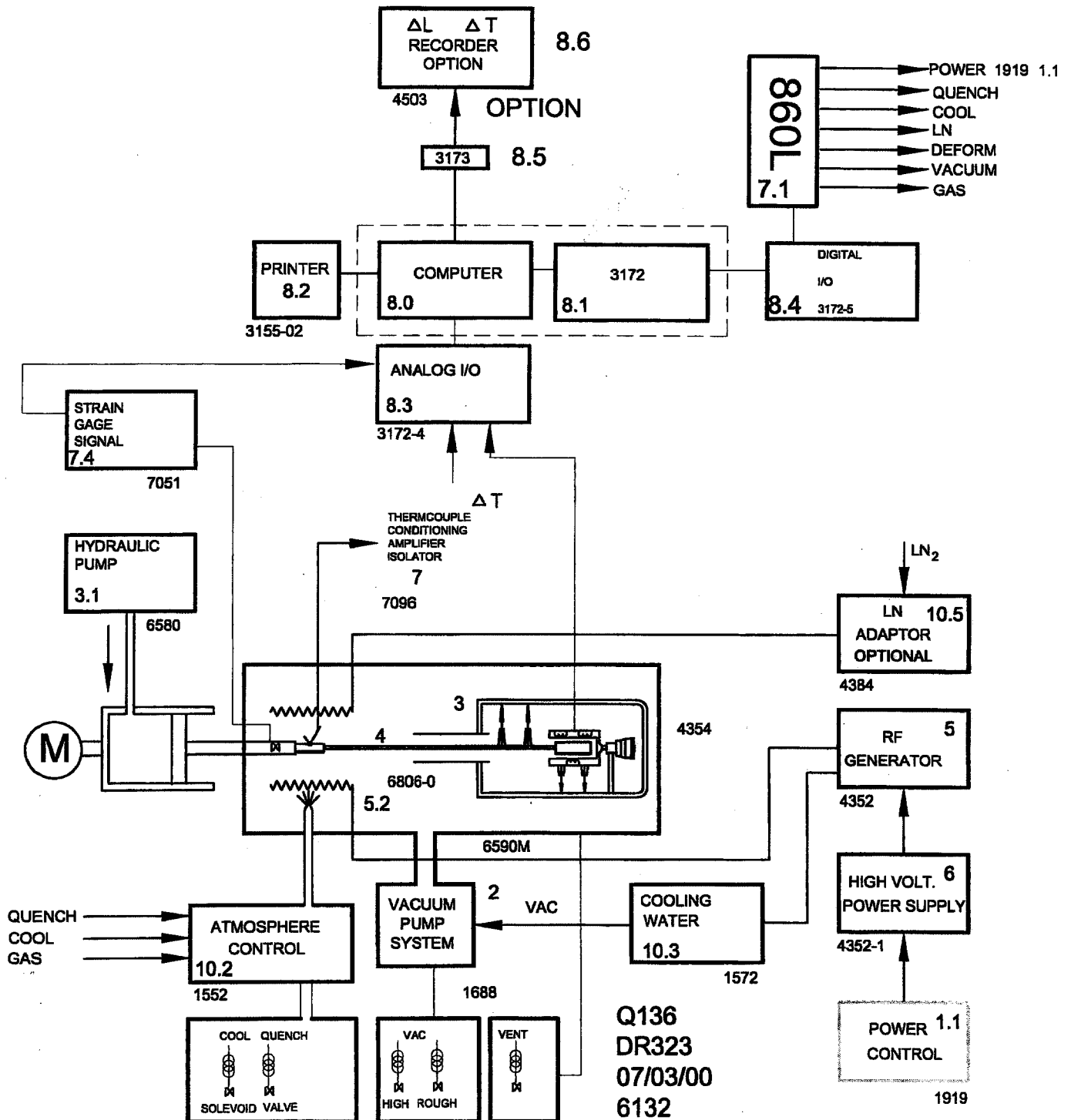

# DILATRONIC III



8.3



3172

9

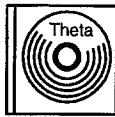

8.2

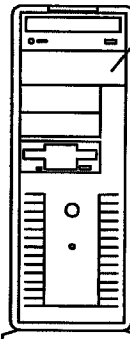
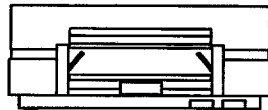

8

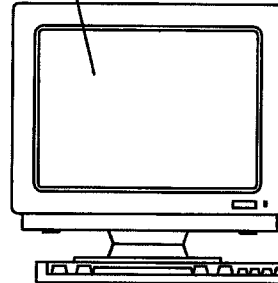

Desk to the right of instrument



4354

5



4356

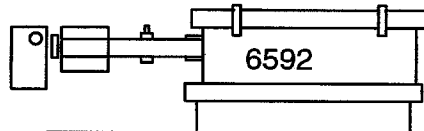

6592

10

1510

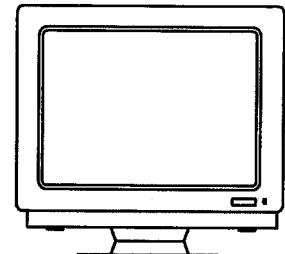

2.0

DR321  
07/03/00  
Dilatronic III  
6132

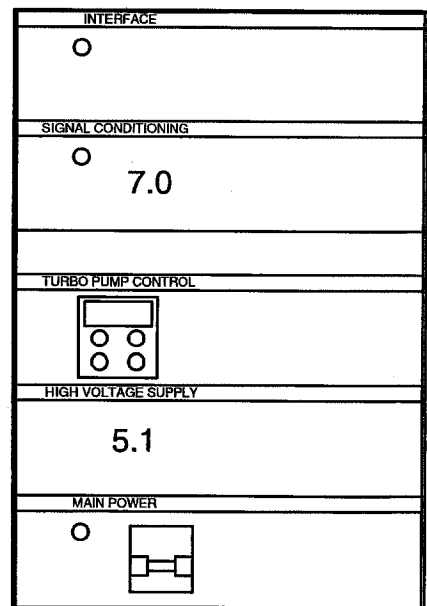
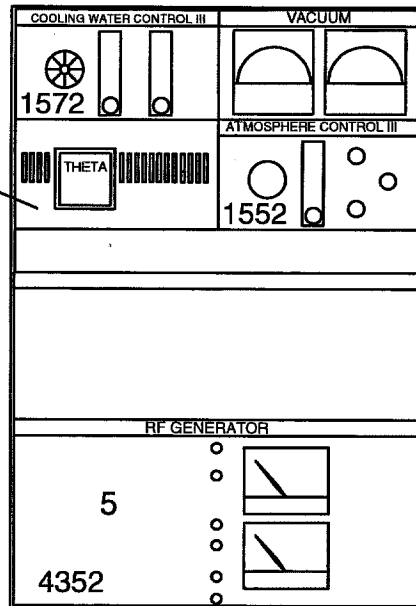

3.1

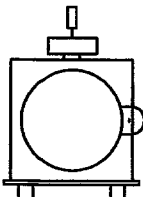

6580

2

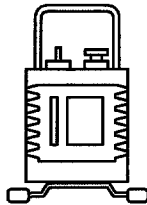

1612

1